



E-mail: distributor@hyggeraquarium.com

Website: www.hyggeraquarium.com



HG129 USER MANUAL

hygger Sun LED Light

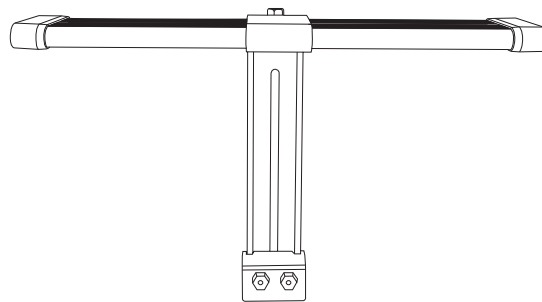

Clip On Style { Model
HG129-20W
HG129-26W

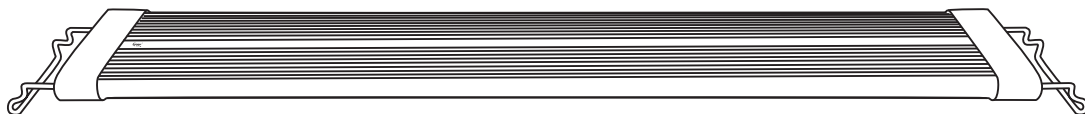

Extendable Legs { Model
HG129-36W
HG129-48W
HG129-60W
HG129-72W

The hygger Sun LED Light is a great way to illuminate your aquariums. With years of expertise, we are one of the pioneers in the field of full spectrum lighting. Easy to use and convenient to program, this lighting is perfect for beginners who want to light their first aquarium and also for professionals who want to upgrade their lighting!

Please read this manual carefully before using and in strict accordance with the manual use.

1.PRODUCT FEATURES

Ultra-bright LEDs: Premium, powerful 5054+2835 LEDs provide stable and bright illumination to bring out the color in your tank and promotes plant growth.

Day & Night Mode and DIY Mode: you can adjust day& night mode or 24/7(DIY) mode to run your light. Each mode features fully customize WRGB color and brightness, flexible time set up option to automatically turn on/off the light, 15 minutes slowly ramp up and down, etc.

Individually controllable colors: White-->Red-->Orange-->Yellow-->Green-->Marnie Blue-->Blue-->Purple

Clip or Extendable bracket for the series light: Metal clip on bracket is for small fish tank up to 24 inches long aquariums, and the extendable bracket is for 24 inches or up aquariums.

Memory function: Cell battery is an extra bonus. Install it on the controller, it will remembers your previous setting and update current time of day so you don't have to reprogram it. No fear of power failure anymore.

Suitable for planted and freshwater aquariums: This full-spectrum LED lighting provides your aquarium plants with the light they need for healthy aquatic plants.

2.PRODUCT PARAMETER

MODEL	HG129-20W	HG129-26W	HG129-36W
LIGHT SIZE (NOT INCLUDING BRACKET)	12x3.9x0.9inch (30x10x2.2cm)	18x3.9x0.9inch (45x10x2.2cm)	24x3.9x0.9inch (60x10x2.2cm)
APPLICATIONS	12-18inch (30-45cm)	18-24inch (45-60cm)	24-30inch (60-76cm)
INPUT VOTAGE	AC100-240V	AC100-240V	AC100-240V
OUTPUT VOTAGE	DC20V	DC20V	DC20V
LED QUANTITY	60PCS	90PCS	120PCS
	White 28pcs	White 41pcs	White 54pcs
	Blue 3pcs	Blue 6pcs	Blue 8pcs
	Red 3pcs	Red 4pcs	Red 6pcs
	Green 2pcs	Green 3pcs	Green 4pcs
	RGB 24pcs	RGB36pcs	RGB 48pcs
RENDERING INDEX	89	89	89
LUMENS	927	1290	1984
COLOR TEMP	6500-10000K	6500-10000K	6500-10000K
POWER CORD	4.9ft (1.5m)	4.9ft (1.5m)	8.8ft (2.7m)

MODEL	HG129-48W	HG129-60W	HG129-72W
LIGHT SIZE (NOT INCLUDING BRACKET)	29.5x3.9x0.9inch (75x10x2.2cm)	35.4x3.9x0.9inch (90x10x2.2cm)	47.2x3.9x0.9inch (120x10x2.2cm)
Size Adjustment	30-36inch (76-91cm)	36-42inch (90-106cm)	48-55inch (120-140cm)
INPUT VOTAGE	AC100-240V	AC100-240V	AC100-240V
OUTPUT VOTAGE	DC20V	DC20V	DC20V
LED QUANTITY	150PCS	180PCS	210PCS
	White 65pcs	White 80pcs	White 94pcs
	Blue 12pcs	Blue 12pcs	Blue 13pcs
	Red 8pcs	Red 10pcs	Red 12pcs
	Green 5pcs	Green 6pcs	Green 7pcs
	RGB 60pcs	RGB 72pcs	RGB 84pcs
RENDERING INDEX	89	89	89
LUMENS	2365	2879	3346
COLOR TEMP	6500-10000K	6500-10000K	6500-10000K
POWER CORD	8.8ft (2.7m)	8.8ft (2.7m)	8.8ft (2.7m)

3.INSTRUCTION

CONTROLLER DIAGRAM

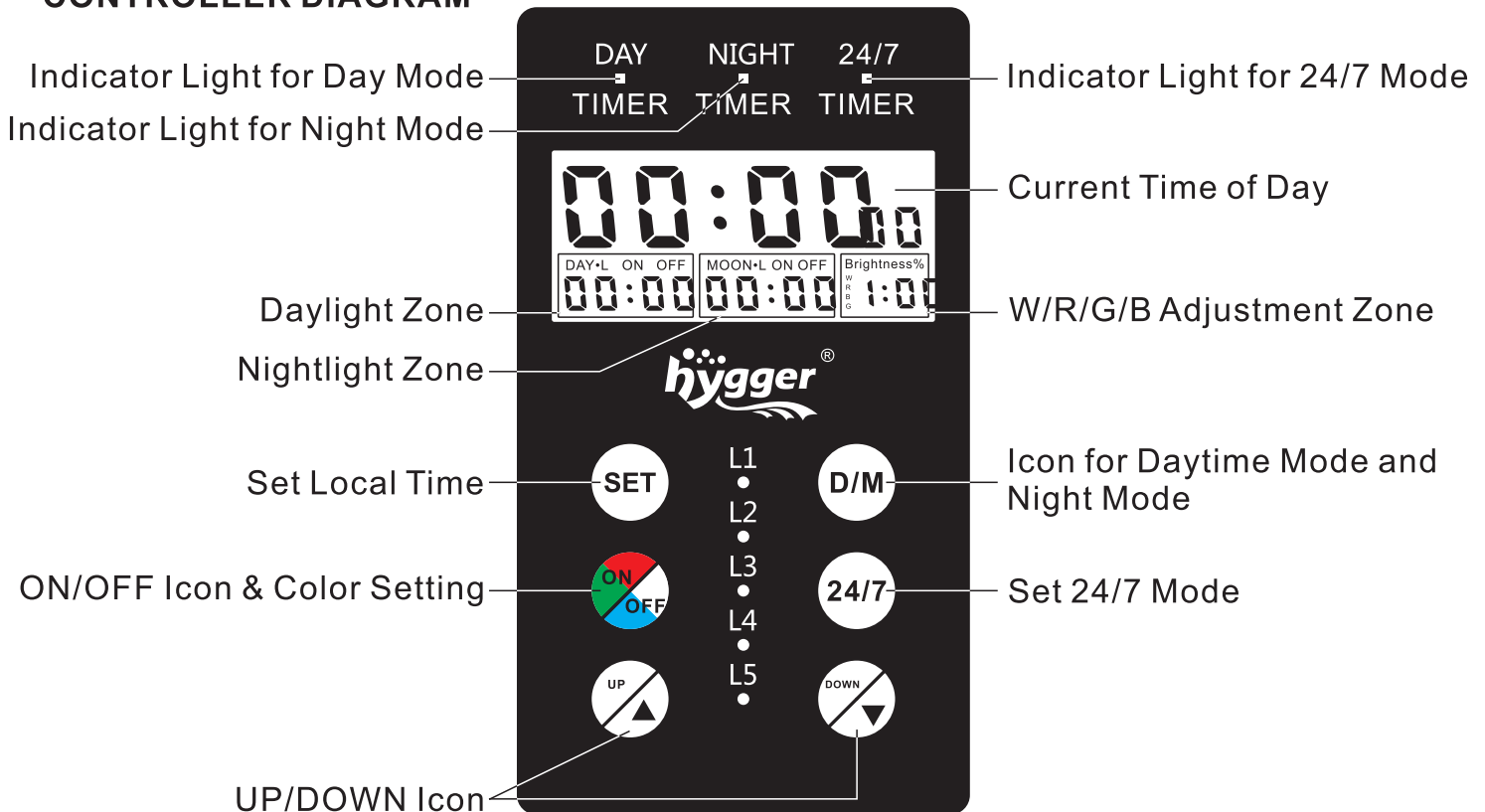

Programming Guide

Note: 1) Please install cell battery(included) to the back of the controller.
2) If the light is inserted into the battery for the first time or it is switched on for the first time in the daytime mode and night mode, the default time and light settings are shown the following. The light will turn on after 6 hours later, LCD display at 06:00 and turn off 23:00.

Day and Moon Light Default Settings(preprogrammed in controller)

Daylight ON Time: 06:00	}	Daylight Color Spectrum - W:100% B:100% R:100% G:100%
Daylight OFF Time: 18:00		
Moonlight ON Time: 18:00	}	Moonlight Color Spectrum - W:0% B:100% R:0% G:0%
Moonlight OFF Time: 23:00		

Please review the following light cycle diagram:

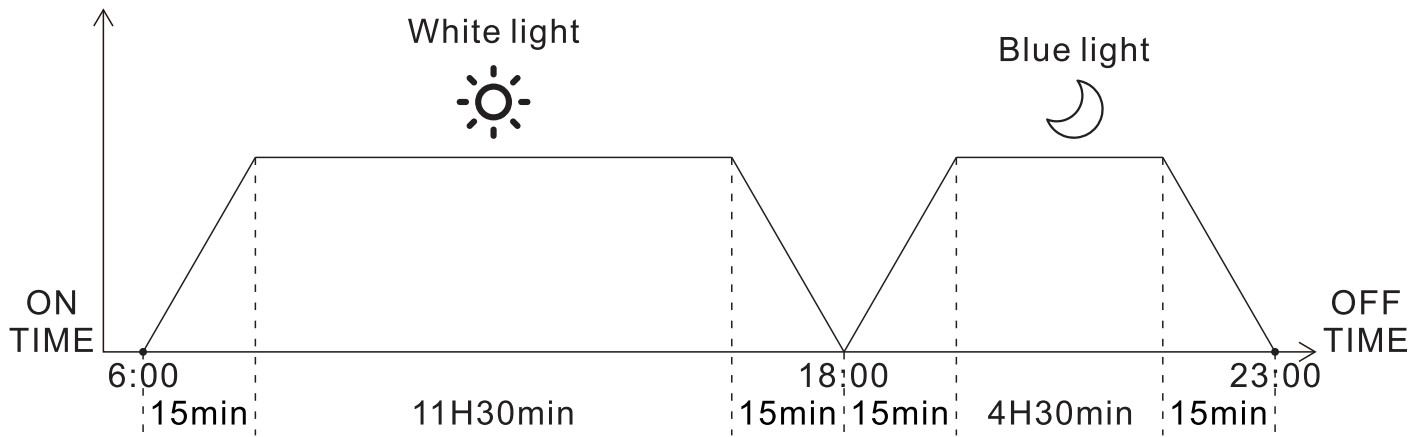

1) Setting Current Time of Day (Before using the light, please set the local time first.)

- 1.Press and hold the SET icon for 5 seconds- > Hour on the main digits will blink.
- 2.Press the UP/DOWN icon to adjust the clock to the current hour of the day - > Hour will change on main digit display.
- 3.Press the SET icon to set minute- > Minute on the main digits will blink.
- 4.Press the UP/DOWN icon to adjust the clock to the current minute of the day - > Minute will change on main digit display.
- 5.Press the SET icon- >24H on the main digits will blink.
- 6.Press UP/DOWN icon to switch 12H to 24H. Choose the desired time.
- 7.Press the SET icon to save.

2) To turn Daylight and Moon light mode ON/OFF

There are 2 modes you can choose from daylight and moon light .

- 1.Press the D/M icon- > S1 will appear on main digit display and DAY-L ON OFF blink, ON appears on the Daylight Zone. S1 represents daylight.
- 2.To turn off daylight, click UP or DOWN icon- > OFF will appear on daylight zone display.
- 3.Press D/M icon to save.
- 4.Press the D/M icon- > S2 will appear on main digit display and MOON-L ON OFF blink. S2 represents moonlight. Same way to turn on/off moonlight.

3) Daylight+Moonlight Setting

- 1.Press and hold the D/M icon for 5 seconds - > "S1" will appear on main digit display and "DAY-L ON" blink
- 2.Press and hold the D/M icon for 5 seconds - > Hour on daylight zone blink

3. Press UP/DOWN icon to adjust the desired daylight ON hour, press the D/M icon to save, Minute on daylight zone blink.
4. Press UP/DOWN icon to adjust the desired ON minute, press the D/M icon to save, "Brightness % W" on color adjustment zone blink.
5. Press UP/DOWN icon to adjust white light desired intensity, % intensity will appear on color adjustment zone.
6. Press ON/OFF icon - > "R" on color adjustment zone blink.
7. Press UP/DOWN icon to adjust red light brightness
8. Press ON/OFF icon- > "B" on color adjustment zone blink.
9. Press UP/DOWN icon to adjust blue light intensity
10. Press ON/OFF icon- > "G" on color adjustment zone blink.
11. Press UP/DOWN icon to adjust green light intensity
12. Press D/M icon to save- > Hour on daylight zone blink
13. Press UP/DOWN icon to adjust the desired OFF hour, press the D/M icon to save, Minute on daylight zone blink.
14. Press UP/DOWN icon to adjust the desired ON minute, press the D/M icon to save- > "MOON-L ON" and "Hour" on moonlight zone blink. Daylight setting is complete and move to moonlight setting.
15. Press UP/DOWN icon to adjust the desired moonlight ON hour, press the D/M icon to save, Minute on daylight zone blink.
16. Press UP/DOWN icon to adjust the desired ON minute, press the D/M icon to save, "Brightness % W" on daylight zone blink.
17. Repeat previous steps to set moonlight ON/OFF time and light color spectrum. You can see day timer and night timer's indicator light is on, indicating the light is running on day and night mode.

NOTE: When set up day and night mode, the display will stay on setting interface for 30 seconds. If no operation within 30 seconds, it automatically exits setting interface back to Current time. You have to reprogram again.

4) 24/7 Timer Mode Setting

1. Press the 24/7 icon - > ON appears on the main digit display which represents 24/7 mode is activated. 24/7 indicator light is on. S3 represents 24/7 mode.
- Note:** To turn off 24/7 mode, simply press 24/7 icon again- > OFF appear on the main display, day and night timer indicator light is on.
2. Press and hold the 24/7 icon until S3 appear on the display- > L1 and 24/7 indicator light blink, Hour on the lower left zone blink
 3. Press the UP/DOWN icon to adjust the desired 24/7 mode's L1 ON hour
 4. Press the 24/7 icon- > minute digit blink.
 5. Press the UP/DOWN icon to adjust the desired L1 ON minute
 6. Press the 24/7 icon to set L1 OFF time- > Hour digit on the middle zone blink.
 7. Press the UP/DOWN icon to adjust the desired L1 OFF hour
 8. Press the 24/7 icon- > "Brightness % W" on color adjustment zone blink.
 8. Press UP/DOWN icon to adjust white light desired intensity
 9. Press ON/OFF icon - > "R" on color adjustment zone blink.
 10. Press UP/DOWN icon to adjust red light brightness
 11. Press ON/OFF icon- > "B" on color adjustment zone blink.
 12. Press UP/DOWN icon to adjust blue light intensity
 13. Press ON/OFF icon- > "G" on color adjustment zone blink.
 14. Press UP/DOWN icon to adjust green light intensity
 15. Follow the above steps to complete the settings of L2-L4.

If the light is inserted into the battery for the first time or it is switched on for the first time in the daytime mode and night mode, the default time and light settings are shown the following.

24/7 Mode Default Settings (preprogrammed in controller)

L1: 08:00 – 09:00 W: 5% R: 5% G: 5% B: 5%
L2: 09:00 – 11:00 W: 50% R: 50% G: 50% B: 50%
L3: 11:00 – 15:00 W: 100% R: 100% G: 100% B: 100%
L4: 15:00 – 19:00 W: 0% R: 0% G: 0% B: 100%
L5: 19:00 – 07:59 W: 0% R: 0% G: 0% B: 0%

Please review the following light cycle diagram:

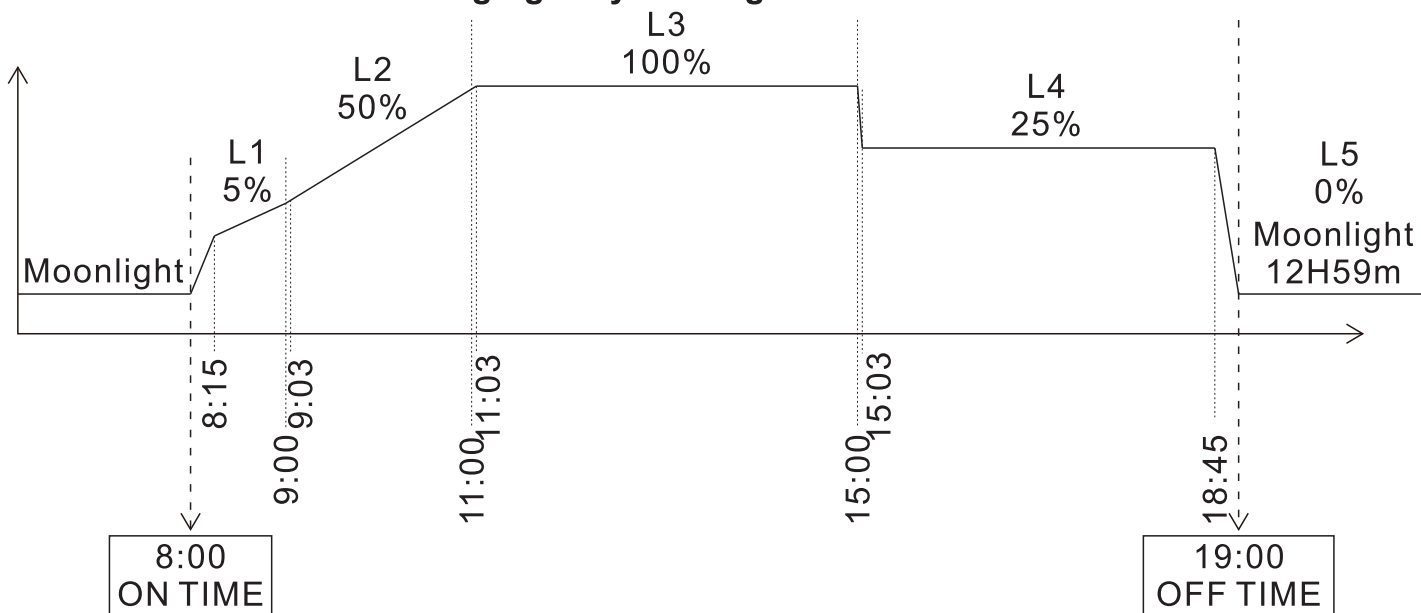

Note:

At 24/7 mode, the light will slowly ramp up to the set light color and intensity at the very first 15 minutes of L1 and L5. And at L2 to L4, the light takes 3 minutes to ramp up.

5) Manual Turn ON/OFF Light

When the light is off, press ON/OFF icon to turn on the light. Click ON/OFF icon to select single color or full spectrum light you preferred. Press UP/DOWN icon to adjust brightness.

press and hold ON/OFF icon to turn off the light.

Funny Light Color Changing Loop

When the light is on, quick press ON/OFF icon twice to turn on light color changing loop (Full Spectrum-Red-Orange-Yellow-Green-Cyan-Blue-Plum)

NOTE: Don't press the button too fast. Please be patient the light and give 2 seconds to allow it to catch up with your instruction.

Additional Help

For additional installation instructions and videos, please visit our website at www.hygger-online.com

4.ATTENTIONS

- √ Please read this user manual carefully before using and follow it strictly.
- √ Please keep the switch away from water since it is not waterproof.
- √ Please keep the light away from flammable items to avoid accidents.
- √ Please unplug the power and contact the seller if the light is not working properly.

****OPENING WILL VOID WARRANTY****

√ Please unplug the power before maintenance.

√ Please mind that the temperature range for the light is between 23°F ~113°F (-5°C~45°C).

5.WARNING

To avoid possible electric shock, do not immerse the switch in the water. If the switch falls into the water or becomes wet, do not touch it until you have unplugged it. Basic safety precautions that should be observed are as follows:

1.Read and follow this user manual strictly.

2.DANGER- To avoid possible electric shock, special care should be taken since water is employed in the use of aquarium equipment. For each of the following situations, do not attempt to repair yourself. Instead, return the light to an authorized service facility for maintenance or discard it.

A.If the light falls into the water, DO NOT touch it. First unplug it, then retrieve it. If electrical components of the light get wet, unplug it immediately.

B.Carefully examine the light after installation. It should not be plugged in if there is water on parts that are not intended to be wet.

C.Do not operate the light if it has a damaged cord or plug, is malfunctioning, dropped, or damaged in any manner. The power cord of this light cannot be replaced. If the cord is damaged, the light should be discarded.

D.To avoid the possibility of the light plug getting wet, position the aquarium and its stand to one side of a wall mounted outlet to prevent water from dripping onto the outlet or plug. A “drip loop”, shown in the figure below, should be arranged by the user for each cord, which connects the light to the outlet. If an extension cord is used, the “drip loop” is the part of the cord below the level of the outlet or the connector that prevents water from traveling along the cord and coming in contact with the outlet. If the plug or outlet does get wet, DO NOT unplug the cord. Disconnect the fuse to the circuit breaker that supplies power to the light. Then, unplug and examine for the presence of water in the outlet. If you are not sure, consult a certified electrician.

POWER CORD



DRIP LOOP

3.Close supervision is necessary when the light is used near children.

4.To avoid injury, do not contact moving or hot parts.

5.Make sure the light is securely installed before operating it.

6.Read and observe all the important notices on the light.

7.If an extension cord is necessary, a cord with a proper rating should be used, such as rated amperes or watts. A cord rated for fewer amperes or watts than the appliance rating may overheat. Care should be taken to arrange the cord so that it will not be tripped over or pulled.

8.The light is intended FOR HOUSEHOLD USE ONLY.

9.SAVE THIS USER MANUAL.

6.HYGGER LIMITED MANUFACTURER’S WARRANTY

We offer the end user of this product a manufacturer warranty of 3(2) years from the date of sale if this product was purchased from a hygger[®]-authorised specialist dealer. Retain receipt for any future warranty claim. Conditions apply. Products are guaranteed by hygger[®] Aquatic Supplies to the original purchaser against defective material and

workmanship under normal use for a period up to 3(2) years from the date of the original purchase through an Authorized Dealer. Refer to the User Manual included with your product for specific warranty details.

Products have no warranty if:

- 1.) The product has been serviced, modified or tampered with by anyone other than hygger® Aquatic Supplies.
- 2.) The product has been abused or damaged (including broken or cracked bulbs), and/ or.
- 3.) The product has been transported without proper packaging.
- 4.) The product was purchased from an Unauthorized Reseller.

WARRANTY LIABILITY DISCLAIMER

In no event will hygger® be liable for any consequential or incidental damages, including but not limited to, lost aquatic life, personal injury, property damage, equipment damage, lost profits, lost wages, lost savings, lost income, etc., arising out of the use of any hygger® products.

1.0. Terms and Conditions of Warranty.

- 1.1. hygger® warrants to the purchaser, for 3 (2) years from date of original purchase through an Authorized hygger® Reseller, free to repair or replace parts where fault is found due to defective materials or faulty workmanship and where goods do not operate in accordance with the instructions.
- 1.2. All claims for repair or replacement must be made at place of purchase.
- 1.3. Only the direct purchaser is entitled to warranty claims against us and these are not transferable without our consent.
- 1.4. The original and dated Proof of Purchase (receipt) must be supplied with all goods claims. Please also provide this Guarantee where possible.
- 1.5. Wear parts (e.g.: seals, suction devices, axes, pump wheels, light sources, pH electrodes, filter media, such as filter cartridges, as well as UVC burners), glass damage and the opening of the product, as well as structural changes or the use of non-hygger® original parts are excluded from the guarantee.
- 1.6. All goods subject to claim under Guarantee should be prepared for transportation in the original packaging or other comparable packaging which offers the same degree of protection and hygger® must incur no costs from the shipment.
- 1.7. Where claims on inspection reveal goods are in normal working order, hygger® will request reimbursement of all reasonable costs incurred.
- 1.8. Warranty claims do not exist in the case of only insignificant deviations from the agreed or customary condition or usability, e.g. insignificant deviations in colour, dimensions and/or quality or performance characteristics of the products.
- 1.9. Our warranty obligation extends only to the delivery of newly manufactured products. Unless otherwise agreed, used products are sold as seen, excluding any warranty.



For more warranty information, please see the hygger website.

7.DISPOSAL

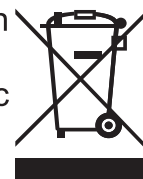
Do not dispose of this product as unsorted municipal waste. Collection of such waste separately for special treatment is necessary. This product has to be disposed of at an authorized place for the recycling of electrical and electronic appliances rather than being disposed of together with the domestic waste. Collecting and recycling waste is a way of saving natural resources. So, please consult with your local seller to make sure the product is disposed of in an environmentally friendly way.



8.WARNING: STATEMENT OF THE BUTTON CELL AND COIN BATTERY

 A WARNING	
<ul style="list-style-type: none">• INGESTION HAZARD: This product contains a button cell or coin battery.• DEATH or serious injury can occur if ingested.• A swallowed button cell or coin battery can cause internal Chemical Burns in as little as 2 hours.• KEEP new and used batteries OUT OF REACH OF CHILDREN• Seek immediate medical attention if a battery is suspected to be swallowed or inserted inside any part of the body.	

- a) The statement "Remove and immediately recycle or dispose of used batteries according to local regulations and keep away from children. Do NOT dispose of batteries in household trash or incinerate."
- b) The statement "Even used batteries may cause severe injury or death."
- c) The statement "Call a local poison control center for treatment information."
- d) A statement indicating the compatible battery type (e.g. CR1220)
- e) A statement indicating the nominal battery voltage.
- f) The statement "Non-rechargeable batteries are not to be recharged."
- g) The statement "Do not force discharge, recharge, disassemble, heat above (manufacturer's specified temperature rating) or incinerate. Doing so may result in injury due to venting, leakage or explosion resulting in chemical burns."
- h) The statement "Ensure the batteries are installed correctly according to polarity (+ and -)."
- i) The statement "Do not mix old and new batteries, different brands or types of batteries, such as alkaline, carbon-zinc, or rechargeable batteries."
- j) The statement "Remove and immediately recycle or dispose of batteries from equipment not used for an extended period of time according to local regulations."
- k) The statement "Always completely secure the battery compartment. If the battery compartment does not close securely, stop using the product, remove the batteries, and keep them away from children."

9.PACKING LIST

- 1x Light with controller
- 1x DC adapter
- 2x Metal extendable legs (for Model HG129 24-inch and up long aquarium light)
- 1x Metal Bracket Clip (for Model HG129 12" and 18" long aquarium light)
- 1 x Button battery
- 1x User manual

10.CONTACT INFORMATION

Distributed by: Hygger Aquarium, Inc.
13941 Magnolia Ave, Chino, CA 91710

E-mail: distributor@hyggeraquarium.com

Website: www.hyggeraquarium.com

Trademarks of Shenzhen Mago Trading Co., Ltd
Bantian Group Business Center, Longgang,
Shenzhen City, China
All Rights Reserved

Made in China